

# Panasonic®

## Advanced Hybrid System

## User Guide

### for Single Line Telephone





---

















Model No. **KX-TA824**



















Please read this guide before using and save for future reference.

# Features List



















 Feature number  
  Off-hook  
  On-hook  
  Talk

Desired Feature	Operation
<b>Making Calls</b>	
Calling	To an extension  ► <span style="border: 1px solid black; padding: 2px;">extension no.</span> ► 
	To an external party  ► <span style="border: 1px solid black; padding: 2px;">phone no.</span> ► 
Redial	 ► <span style="border: 1px solid black; padding: 2px;">8</span> <span style="border: 1px solid black; padding: 2px;">0</span> / <span style="border: 1px solid black; padding: 2px;">#</span> <span style="border: 1px solid black; padding: 2px;">#</span> ► 
Calling an operator	 ► <span style="border: 1px solid black; padding: 2px;">0</span> ► 
Speed Dialing (Personal)	To store  ► <span style="border: 1px solid black; padding: 2px;">2</span> <span style="border: 1px solid black; padding: 2px;">*</span> ► <span style="border: 1px solid black; padding: 2px;">personal speed dial no.</span> ► <span style="border: 1px solid black; padding: 2px;">desired no.</span> ► <small>(0-9)</small> ► <span style="border: 1px solid black; padding: 2px;">#</span> ► 
	To dial  ► <span style="border: 1px solid black; padding: 2px;">1</span> <span style="border: 1px solid black; padding: 2px;">*</span> / <span style="border: 1px solid black; padding: 2px;">#</span> ► <span style="border: 1px solid black; padding: 2px;">personal speed dial no.</span> ►  <small>(0-9)</small>
Speed Dialing (System)	To dial  ► <span style="border: 1px solid black; padding: 2px;">*</span> ► <span style="border: 1px solid black; padding: 2px;">system speed dial no.</span> ►  <small>(00-99)</small>
<b>Receiving Calls</b>	
Picking up a call	 ► <div style="border: 1px dashed black; padding: 10px; display: inline-block; margin-left: 20px;"> <p style="margin: 0;"><b>Directed</b></p> <p style="margin: 0;"><span style="border: 1px solid black; padding: 2px;">4</span> ► <span style="border: 1px solid black; padding: 2px;">extension no.</span></p> <p style="margin: 0;"><b>Group</b></p> <p style="margin: 0;"><span style="border: 1px solid black; padding: 2px;">4</span> <span style="border: 1px solid black; padding: 2px;">0</span></p> </div> ► 











# Features List

Desired Feature	Operation	
<b>When the Dialed Extension is Busy/No Answer</b>		
Automatic Callback Busy	<b>To set</b> <i>While hearing a busy tone</i>  ▶ <b>6</b> ▶ 	<b>To call</b> <i>If you hear callback ringing</i> 
Message Waiting	Sender	<b>To leave a notification</b>  ▶ <b>7 0</b> ▶ <b>1</b> ▶ <b>receiver's extension no.</b> ▶ ▶ <b># / 0</b> ▶  <hr/> <b>To cancel a notification</b>  ▶ <b>7 0</b> ▶ <b>2</b> ▶ <b>receiver's extension no.</b> ▶ ▶ <b># / 0</b> ▶ 
	Receiver	<b>To call back</b>  ▶ <b>7 8 4</b> ▶ <b>#</b> ▶  <hr/> <b>To clear all notifications</b>  ▶ <b>7 0 0</b> ▶ <b>#</b> ▶ 
Call Waiting	Sender	<i>While hearing a busy tone</i> <b>1</b> ▶ Wait for an answer. ▶ 
	Receiver	 ▶ <div style="border: 1px dashed black; padding: 10px; display: inline-block; margin: 10px;"> <p><b>For outside calls</b></p> <p><b>7 3 1 1 #</b> Set</p> <p><b>7 3 1 0 #</b> Cancel</p> <p><b>For intercom calls/doorphone calls</b></p> <p><b>7 3 2 1 #</b> Set</p> <p><b>7 3 2 0 #</b> Cancel</p> </div> ▶  <hr/> <b>To talk to the new party</b> <i>While hearing the Call Waiting tone</i> <b>Terminating a current status</b>  ▶  ▶ 



# Features List

Desired Feature	Operation
<b>During a Conversation</b>	
Holding a call	<p><b>Holding</b></p>  ►  <span style="margin-left: 100px;">To retrieve a call at the holding extension</span> 
	<p><b>To retrieve an outside call from another extension</b></p>  ► <span style="border: 1px solid black; padding: 2px;">5</span> <span style="border: 1px solid black; padding: 2px;">3</span> ► <span style="border: 1px solid black; padding: 2px;">held line no.</span> ► 
Transferring a call	 ► <span style="border: 1px solid black; padding: 2px;">extension no.</span> To an extension ► Wait for an answer. ►  ►  <p style="text-align: right; margin-right: 50px;">Announce.</p>
<b>Useful Features</b>	
Paging	<p><b>To page</b></p> <div style="border: 1px dashed black; padding: 10px; margin: 10px 0;"> <p>All extensions  <span style="border: 1px solid black; padding: 2px;">3</span> <span style="border: 1px solid black; padding: 2px;">3</span> <span style="border: 1px solid black; padding: 2px;">0</span></p> <p>Group  <span style="border: 1px solid black; padding: 2px;">3</span> <span style="border: 1px solid black; padding: 2px;">3</span> ► <span style="border: 1px solid black; padding: 2px;">group no.</span></p> <p>All external speakers  <span style="border: 1px solid black; padding: 2px;">3</span> <span style="border: 1px solid black; padding: 2px;">4</span></p> <p>All extensions &amp; external speakers  <span style="border: 1px solid black; padding: 2px;">3</span> <span style="border: 1px solid black; padding: 2px;">3</span> <span style="border: 1px solid black; padding: 2px;">*</span></p> </div>  ►  <p style="text-align: right; margin-right: 50px;">Announce.</p>
	<p><b>To answer an announced page</b></p>  ► <span style="border: 1px solid black; padding: 2px;">4</span> <span style="border: 1px solid black; padding: 2px;">3</span> ► 
Three-party conference	 ► <span style="border: 1px solid black; padding: 2px;">third party's no.</span> ►  ►  <span style="border: 1px solid black; padding: 2px;">3</span>
Setting Absent Message	<p><b>To set</b></p>  ► <span style="border: 1px solid black; padding: 2px;">7</span> <span style="border: 1px solid black; padding: 2px;">5</span> ► <span style="border: 1px solid black; padding: 2px;">message no.</span> ► <span style="border: 1px solid black; padding: 2px;">parameter (if required)</span> ► <span style="border: 1px solid black; padding: 2px;">#</span> ► 
	<p><b>To cancel</b></p>  ► <span style="border: 1px solid black; padding: 2px;">7</span> <span style="border: 1px solid black; padding: 2px;">5</span> <span style="border: 1px solid black; padding: 2px;">0</span> <span style="border: 1px solid black; padding: 2px;">#</span> ► 

# Features List

Desired Feature	Operation																												
<b>Useful Features</b>																													
Log-In/Log-Out	 ▶ <table border="1" data-bbox="386 263 666 327" style="display: inline-table; vertical-align: middle;"> <tr> <td>7</td><td>3</td><td>6</td><td>0</td><td>#</td> </tr> <tr> <td>7</td><td>3</td><td>6</td><td>1</td><td>#</td> </tr> </table> <span style="display: inline-block; vertical-align: middle; margin-left: 10px;">For Log-In For Log-Out</span> ▶ 	7	3	6	0	#	7	3	6	1	#																		
7	3	6	0	#																									
7	3	6	1	#																									
Forwarding a call	 ▶ <table border="1" data-bbox="364 606 481 638" style="display: inline-table; vertical-align: middle;"> <tr> <td>7</td><td>1</td> </tr> </table> ▶ <div style="border: 1px dashed black; padding: 10px; margin: 10px auto; width: 80%;"> <p><b>All calls</b>  <table border="1" data-bbox="532 391 800 422" style="display: inline-table; vertical-align: middle;"> <tr> <td>1</td> <td>▶ extension no. ▶</td> <td>#</td> </tr> </table> </p> <p><b>Busy/No answer</b>  <table border="1" data-bbox="532 446 800 478" style="display: inline-table; vertical-align: middle;"> <tr> <td>2</td> <td>▶ extension no. ▶</td> <td>#</td> </tr> </table> </p> <p><b>To an outside line</b>  <table border="1" data-bbox="532 510 912 542" style="display: inline-table; vertical-align: middle;"> <tr> <td>3</td> <td>▶ line access code ▶</td> <td>phone no. ▶</td> <td>#</td> </tr> </table> </p> <p><b>Follow Me</b>  <table border="1" data-bbox="532 574 845 606" style="display: inline-table; vertical-align: middle;"> <tr> <td>5</td> <td>▶ your extension no. ▶</td> <td>#</td> </tr> </table> </p> <p><b>Cancel Follow Me</b>  <table border="1" data-bbox="532 630 845 662" style="display: inline-table; vertical-align: middle;"> <tr> <td>8</td> <td>▶ your extension no. ▶</td> <td>#</td> </tr> </table> </p> <p><b>Cancel</b>  <table border="1" data-bbox="532 686 644 718" style="display: inline-table; vertical-align: middle;"> <tr> <td>0</td> <td>▶ #</td> </tr> </table> </p> <p><b>To Voice Mail</b></p> <p><b>All calls</b>  <table border="1" data-bbox="532 790 845 821" style="display: inline-table; vertical-align: middle;"> <tr> <td>1</td> <td>▶ VPS extension no. ▶</td> <td>#</td> </tr> </table> </p> <p><b>Busy/No answer</b>  <table border="1" data-bbox="532 845 845 877" style="display: inline-table; vertical-align: middle;"> <tr> <td>2</td> <td>▶ VPS extension no. ▶</td> <td>#</td> </tr> </table> </p> <p><b>Cancel</b>  <table border="1" data-bbox="532 901 644 933" style="display: inline-table; vertical-align: middle;"> <tr> <td>0</td> <td>▶ #</td> </tr> </table> </p> </div> <span style="display: inline-block; vertical-align: middle; margin-left: 10px;">▶ </span>	7	1	1	▶ extension no. ▶	#	2	▶ extension no. ▶	#	3	▶ line access code ▶	phone no. ▶	#	5	▶ your extension no. ▶	#	8	▶ your extension no. ▶	#	0	▶ #	1	▶ VPS extension no. ▶	#	2	▶ VPS extension no. ▶	#	0	▶ #
7	1																												
1	▶ extension no. ▶	#																											
2	▶ extension no. ▶	#																											
3	▶ line access code ▶	phone no. ▶	#																										
5	▶ your extension no. ▶	#																											
8	▶ your extension no. ▶	#																											
0	▶ #																												
1	▶ VPS extension no. ▶	#																											
2	▶ VPS extension no. ▶	#																											
0	▶ #																												
Do Not Disturb (DND)	 ▶ <table border="1" data-bbox="386 1013 520 1045" style="display: inline-table; vertical-align: middle;"> <tr> <td>7</td><td>1</td> </tr> </table> ▶ <table border="1" data-bbox="565 989 800 1061" style="display: inline-table; vertical-align: middle;"> <tr> <td>4</td><td>#</td> <td>Set</td> </tr> <tr> <td>0</td><td>#</td> <td>Cancel</td> </tr> </table> ▶ 	7	1	4	#	Set	0	#	Cancel																				
7	1																												
4	#	Set																											
0	#	Cancel																											
Locking your extension	(Lock code is 4 digits.)  ▶ <table border="1" data-bbox="403 1125 823 1197" style="display: inline-table; vertical-align: middle;"> <tr> <td>7</td><td>7</td><td>lock code</td><td>lock code</td><td>▶ #</td> <td rowspan="2" style="vertical-align: middle;">Lock</td> </tr> <tr> <td>7</td><td>7</td><td>lock code</td><td>▶ #</td> <td>Unlock</td> </tr> </table> ▶ 	7	7	lock code	lock code	▶ #	Lock	7	7	lock code	▶ #	Unlock																	
7	7	lock code	lock code	▶ #	Lock																								
7	7	lock code	▶ #	Unlock																									
Clearing the setting	 ▶ <table border="1" data-bbox="386 1236 537 1268" style="display: inline-table; vertical-align: middle;"> <tr> <td>7</td><td>9</td><td>#</td> </tr> </table> ▶ 	7	9	#																									
7	9	#																											

# Features List

Desired Feature	Operation	
<b>Making Use of the Voice Mail Service</b>		
Listening to a message	From your own extension	 ▶ <b>VPS extension no.</b> ▶ ▶ <b>VPS password</b> <b>#</b> • If you have no password, you can skip the last step.
	From someone else's extension	 ▶ <b>VPS extension no.</b> ▶ ▶ <b>#</b> <b>6</b> ▶ <b>*</b> ▶ ▶ <b>mailbox no.</b> ▶ ▶ <b>VPS password</b> <b>#</b> • If you have no password, you can skip the last step.
Leaving a message	 ▶ <b>VPS extension no.</b> ▶ <b>#</b> <b>6</b> ▶ ▶ <b>mailbox no.</b> / <b>#</b> <b>1</b> ▶ Enter the first 3 or 4 letters of the desired name ▶ ▶ Leave a message	
During playback	<b>0</b> Repeat Voice Guidance <b>*</b> Exit Menu	

- KX-TVA series**
  - 1** Listen to Message
  - 2** Deliver Message
  - 3** Mailbox Management
  - 4** Automated Attendant
  - 5** Message Notification
  - 6** Other Features
  - \*** End Call
- KX-TVS series**
  - 1** Listen to Message
  - 2** Deliver Message
  - 3** Check Mailbox Distribution
  - 4** Automated Attendant
  - 5** Mailbox Management
  - 6** Other Features
  - \*** End Call

***NOTE***

---

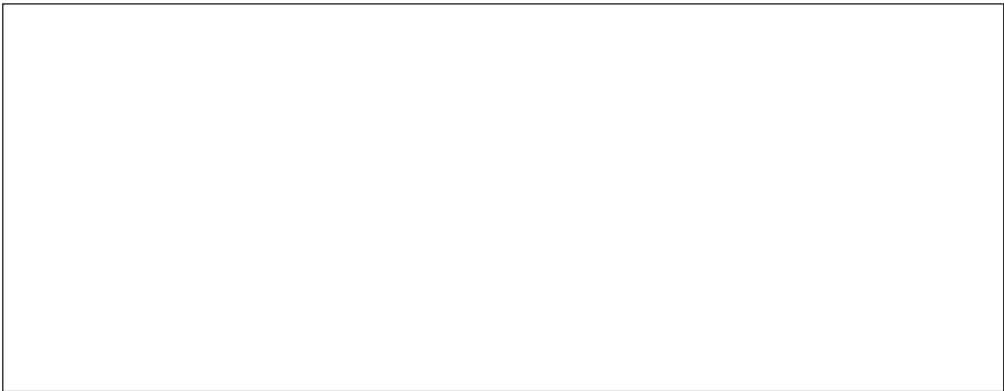

**Panasonic Consumer Electronics  
Company Division of Panasonic  
Corporation of North America**  
One Panasonic Way,  
Secaucus, New Jersey 07094  
<http://www.panasonic.com/csd>

**Panasonic Puerto Rico, Inc.**  
Ave. 65 de Infantería, Km. 9.5,  
San Gabriel Industrial Park, Carolina,  
Puerto Rico 00985

© 2005 Panasonic Communications Co., Ltd. All Rights Reserved.

**PSQX3430YA** KK0405ST1105